

Intelligent Channel State Estimation for 6G Communication Systems Using Deep Learning

J. Snehalatha¹, Ananda Babu Kancherla²

¹*Assistant Professor, Department of ECE, Mahatma Gandhi Institute of Technology, India*

²*Assistant Professor, Department of EEE, Sasi Institute of Technology and Engineering, India*

Email: anandababukancherla@sasi.ac.in

As the world moves towards the development of 6G communication systems, there is a growing need to overcome the challenges posed by the ever-increasing demand for higher data rates, massive connectivity, and ultra-low latency. So this project proposes an enhanced wireless channel state estimation through deep learning for 6g communication. The communication chain begins with a source encoder, which efficiently encodes the input data, followed by a channel encoder that introduces redundancy for error correction. The encoded data is then fed into a symbol mapper to modulate the information into symbols suitable for transmission over the communication channel. The innovative aspect of this work lies in the incorporation of a DL-based channel estimator. The channel estimator encompasses two key stages: channel data acquisition and data-driven learning. The acquisition stage gathers real-time channel data, providing the necessary input for the subsequent data-driven learning phase. Through DL techniques, the system learns the intricate characteristics of the communication channel, adapting to dynamic variations and optimizing the estimation process. The estimated channel output, refined through the DL-based channel estimator, is employed to enhance the overall communication system's reliability and performance. The proposed approach not only offers improved accuracy in channel estimation but also exhibits adaptability to changing channel conditions, making it suitable for real-world communication scenarios. This project is implemented by using MATLAB Software.

1. Introduction

Wireless communication technology have seen tremendous growth in the last several decades. The "Internet of Everything" is made possible by 5G, a mobile communication technology that offers low-latency, large-connectivity, and high-speed capabilities. Its primary applications include, but are not limited to, uRLLC, enhanced mobile broadband, and massive machine-type communications (mMTC). The deployment of Internet of Things (IoT) devices is expected to reach an incredible pace of 152,200 per minute by 2025, according to International Data Corporation (IDC). More than 73.1 zB of data is expected to be generated by IoT devices globally. Massive issues with 5G stem from the ever-increasing number of wireless devices; the performance of the technology has to increase at an exponential pace to accommodate the

ever-increasing demand for mobile data traffic and various services. Still, sixth-generation (6G) network designs are already underway. Security, transmission speed, throughput, energy efficiency, and spectrum efficiency are some of the key areas where 6G is expected to surpass 5G. In wireless communication systems, the channel is complex and dynamic. The multipath effect, shadow fading, the Doppler effect, and other signal attenuation and distortion processes may have a detrimental influence on the operation of communication systems. Channel estimation seeks to estimate CSI at the receiver, which is critical for the accuracy of both sent and received signals. To recover precise data during receiver demodulation, it is necessary to make an accurate channel estimate so that one may adjust the amplitude and phase of the received signal. This is why channel estimation is so important in physical-layer wireless communication. We can solve 5G's performance limitations, make 6G's "Intelligent Interconnection of Everything" a reality, and dramatically enhance communication network quality.

2. Literature Survey

Bhekisizwe Mthethwa et al [2020] The proposed uncoded space-time labelling diversity applies labelling diversity to a space-time block-coded system to improve wireless connection reliability while maintaining spectral efficiency. The connection reliability achieved by USTLD is higher than that of the traditional alaboudi system. In order to estimate the channel, channel estimating systems need prior knowledge of the broadcast pilot symbols, channel statistics, and receiver noise variance. A neural network machine learning channel estimator with transmit power sharing is being studied to ease the system's blind channel estimation and lower the bandwidth consumption of channel estimate. The study's findings showed that the design relied heavily on the MIMO receiver antenna configuration. The fitness values are significantly different from one another to avoid the computation of matching selection probabilities when the validation MSE values are very close. The power fraction also can't move linearly to unity because the information symbols' transmit power will become so low that the transmitted symbols' BER performance suffers. Therefore, it doesn't need to know the second-order statistics of the wireless channel or the noise variance.

Hamza Djelouat et al [2021] Reduced signalling overhead and latency made possible by the proposed agrant-free random access greatly enhances machine-type communications' energy efficiency. It was the compressive sensing problem that JUICE fixed, which was caused by the intermittent mMTC traffic. The simulation results show that the strategy significantly improves user identification accuracy and channel estimation performance while lowering signalling overhead compared to the baseline techniques. Granted random access techniques aren't adequate to the task of sustaining very large connections. It opens the door for a closed-form solution to a subproblem of an optimisation approach. This technique outperforms baseline MMV JUICE while requiring less signalling overhead. The main advantages of grant-free access over typical random access are reduced signalling overhead and enhanced energy efficiency of the IoT devices. A simple and efficient framework that is problem-friendly with high-dimensional optimisation. The covariance data makes it much easier to find the actual set of active users. The channel spatial correlation changes at a slower rate than the channel realisations, and the channel covariance matrices for all IoT devices are computed with high

accuracy.

Sai Huang et al [2021] shown that the quality of communication services is guaranteed by the use of accurate channel estimates in time-varying channels, especially in scenarios where vehicles link to every item. Millimetre wave channel estimates made easier by multi-input, multi-output radar help pilots save time and get more accurate results. In the gain estimate process, a DL-based channel gain estimator is created. The residual denoising autoencoder is a structure that uses autoencoders to reduce noise from wireless communications. The least squares estimation module receives the output signal and uses it to generate gains. Because of its low penetration and high attenuation, massive MIMO is essential for high-gain focused beam production. Assuming high-tech equipment, digital precoding enables many channels to broadcast at the same time, catering to multiple customers. An very advanced method for ultra-high-resolution estimation.... Allows for more precise estimations and can adjust to highly mobile channels that change over time. In situations when vehicles are travelling at high speeds, the method accurately predicts the mm Warp channels that fluctuate with time.

Junfeng Wang et al [2020] For a network for wireless communication, the Rice factor ratio is a key performance indicator for the channel (because it reveals the severity of the small-scale fading) and for utilising as previous information for predicting other metrics, such as frequency. This means that its estimation is vital in a lot of wireless application contexts. Noise variance, maximum Doppler shift, indistinguishable multipaths, and Doppler shift are some of the extraneous elements that are eliminated by this. Finally, an equation for the RFR estimation is derived for the Rician frequency selective fast fading channels using a mathematically flexible technique. Increasing the duration of the aided data somewhat improves performance estimation, and the investigated system is robust to signal-to-noise ratio over and frequency offset. Which are common in wireless communication systems and especially prevalent in high-speed wireless communications. The ever-increasing need for massive data rates in wireless communications has necessitated the adoption of wideband and time-varying wireless communication standards and technologies. Every bin does not include every channel multipath component. By reducing algorithm complexity and doing away with the need for additional parameter estimations and a priori knowledge of the maximum Doppler shift or the Doppler shift, the explored approach prevents error propagation.

Qiang Hu et al [2021] shown that deep learning can be an effective tool for predicting channels in wireless communication systems, even under less-than-ideal conditions. It is very difficult to improve and extend DL techniques because to a lack of knowledge about how they function, even though they are incredibly successful. The corresponding DL estimator efficiently achieves universal approximation to a large family of functions by using piecewise linearity. This is because, theoretically, a piecewise linear function is similar to a deep neural network with a rectified linear unit activation function. It is possible to estimate the least mean-squared error in many situations using signal models and asymptotically approaches, even without prior knowledge of the channel statistics. Discordance exists between the statistics used for training and those employed in real-world deployment scenarios. Inputs restricted to regions with non-empty training samples are the only ones that will provide correct channel estimates, as stated in Remark; outside of these regions, the estimates will behave arbitrarily. Because of the restricted effective input range and the indisputable chance that the training data statistics would not match the real channels, this might lead to serious issues. Nonlinear models severely

diminish the effectiveness of the linear LS and LMMSE estimators. To understand when DL embedded communication systems are the way to go, one must be aware of the constraints imposed by DL methods on wireless communication networks.

Zhao Yi et al [2020] shown that deep learning is not only applicable in ideal but also in less-than-ideal conditions for wireless communication network channel predictions. Deep learning (DL) approaches are very successful, but they are still under-researched, which makes it hard to improve and extend them. Matching DL estimators with piecewise linearity efficiently achieve universal approximation to a large family of functions. This is because, in principle, piecewise linear functions are conceptually similar to rectified linear unit activation functions in deep neural networks. Asymptotically approaches and signal models may frequently be used to estimate the least mean-squared error, even when the channel statistics are not known in advance. In real deployment scenarios, the data used for training does not match up with the data used for training. Limiting inputs to regions with non-empty training samples is necessary for reliable channel estimations, as stated in Remark. Without objectivity, the estimations would behave erratically. The short effective input range and the very real chance that training data statistics don't match up with real channels are two potential sources of problems. The linear LS and LMMSE estimators lose a lot of their effectiveness when dealing with nonlinear models. Decisions on the use of DL embedded communication systems may be better made when one is aware of the constraints imposed by DL methods on wireless communication networks.

Ying GAO et al [2023] developed a radio environment map that displays the key wireless communication terminals' coverage in fine detail. There is a tight relationship between the radio environment and the spatial estimation of the channel state. By limiting the amount of trust nodes added, it safeguards the system from harmful impacts and guarantees correct channel condition estimates. Unfortunately, there is a dearth of environmental data, which makes REM construction errors significant, and operating and maintaining large-scale sensor networks expensive and difficult. In real-world applications of the technology, such as collecting data from several mobile phones, it becomes difficult to verify that all participants are being truthful. Apart from that, there will always be selfish users that attempt to monopolise the spectrum or impede the communications of others. Using the average mesh power as their foundation, two of the options up there provide a superior REM. Use the raw data from the normal terminals to conduct interpolation; calculating the average power of each mesh is unnecessary. The database doesn't know which terminals are malicious, hence this strategy's accuracy is seen as the best that can be achieved. Intentionally transmit inaccurate sensor data to the database while working together. Collaborative detection accuracy is drastically reduced (blue bar) as a result of these CSS attacks, which cause the database to retain less data for the right purpose, according to the trust nodes aided phase.

Nahid Parvaresh et al [2023] proposed an alternative to ground-based base stations—base stations mounted on unscrewed aerial vehicles, or drone base stations—to address the issues with the former. Use its mobility to swiftly change their places in reaction to changes in demand. Making the most of the mobility and, by extension, the network's performance, requires optimising the 3D location of UAV-BSs in real time. The model's simulation results demonstrate a significant improvement in the network's performance compared to Q-learning, deep Q-learning, and conventional approaches. In order to estimate for this NP-hard problem,

non-deterministic solutions are necessary. Typically, an agent is limited to choose a single action from a discrete action space, which is a finite collection of alternatives. During the testing phase, the agent has become proficient with the environment and user movement patterns. Endpoint service latency might be drastically reduced by UAV-BSs since these drones are continuously circling regions with high user density and demand. In addition to cellular connections, they bring out other important points that must be addressed for a UAV-assisted cellular network to function well.

Liqiang wang et al [2021] proposed Despite the fact that a dense deployment of VLC access points greatly restricts user mobility, it is considered an essential supplemental technology for very high sixth-generation data transmission rates. A 6G indoor network architecture that incorporates it is presently in the works. An adaptive changeover mechanism employs a smooth handover protocol and a selection algorithm optimised for deep reinforcement learning to circumvent these issues. Many problems remain unsolved, despite the many advantages of VLC. The performance of the RL algorithms employed in the aforementioned study is significantly reduced due to constraints on the Q-table in a large-scale interior scenario with an ultradense deployment of VLC APs. The problem is that harmful feedback from distant and pointless contacts lowers the algorithm's learning efficacy. Pre-existing data set samples are not necessary for learning in the real world. With this hybrid setup, you won't be able to stay connected to a single access point for long without constantly switching between them.

Khaled M. Naguib et al [2023] Virtual reality data transfer on 6G cellular networks requires a high throughput and a very reliable low-latency connection. In conclusion, the suggested technique achieves end-to-end management. In the group of VR users that utilise deep learning, both supervised and unsupervised, to manage resources centrally. Optimal allocation of RBs and optimal utilisation of network resources to meet end-to-end connectivity requirements are achieved by our research, even if UDL is the preferred method when latency is not a major concern. The tagged dataset required to train SDL is often unavailable in some network scenarios. By raising the connection time threshold, SDL and UDL converge, satisfying the latency and performance needs of almost all VR users and drawing closer to each other in terms of total customer satisfaction. With both models running in tandem, the network's capacity to handle more users increases but SDL's relative performance advantage over UDL decreases. The potential for technological advancements to revolutionise VR and other immersive VR experiences is really exciting.

Burak Ozpoyraz et al [2022] as a result of its remarkable representational power and computational simplicity, deep learning has achieved remarkable success in a wide range of domains, including computer vision, natural language processing, and voice recognition. There have been new applications and use cases that have emerged with rigorous needs for next-generation wireless communications, as we move ahead to a fully intelligent society with 6G wireless networks. In order to establish the groundwork for exciting 6G applications, this article primarily aims to reveal the latest state-of-the-art developments in the area of DL-based physical layer approaches. Payed special emphasis to four encouraging physical layer ideas that are expected to rule the roost in next-generation communications, including massively parallel input/output systems. The time frequency grid of OFDM permits the versatile utilisation of resource components, which is particularly useful in light of the literature's scant treatment of, and need for, the programming and implementation stages of DL ideas. Due to

the indefinite degree of mobility, the system parameters cannot be set as constants. Large networks requiring authentication of several nodes may be handled via DL-based approaches described in the literature. The current body of work is so young that it mostly takes undeveloped concepts into account. They may be used to a wide range of DL networks and system models. Among these systems' shortcomings is the presumption of the existence of initial CSI. Problems with using DL-based solutions for MC waveforms have not yet been resolved. We want to include these technologies into our 6G framework in the future, since the DL literature on them is still in its early stages of development.

Martin H. Nielsen et al [2022] Manufactured satellites in low Earth orbit are anticipated to emerge as a major provider of wireless connectivity in the near future. The deployment of 5G and 6G networks in satellite communication is vital for this to come to fruition. The issue of power-efficient transmissions is accompanied by this. A two-step training procedure, with the first step training using an AWGN channel and a static non-linear front end. In the second step, the training time is drastically reduced by adapting to flat fading channels and changing the front end model to adjust for varied front ends using transfer learning. More accurate channels and outcomes about its model retraining for various amplifiers, steering angles, and power levels were missing. The transmitter has to be pushed non-linearly to maintain efficiency. The generalisation is excellent for the same AiP. Bit prediction allows for compensation of both output power fluctuation and steering angle variation, allowing for acceptable BER to be maintained even with heavy signal distortion. Geometrically, the distance to the base station will not be constant. The non-linearity and residual noise are to blame for the minor discrepancies. This allows us to keep our transmitter design unchanged. Since band-pass filtering is often built into most satellite transmitters prior to signal feeding to antenna in order to meet interference standards set by the International Telecommunication Union, this is not a problem.

Faris B. Mismar et al [2023] provided an explanation of how the base station may facilitate handoffs between beams belonging to the same or separate BSs by using deep learning and time series data produced from user equipment beam measurements and locations. To investigate the efficacy of the proactive beam handoff prediction, three distinct methods using long short-term memory recurrent neural networks were used, along with varying the amount of beam measurement look-backs. The transmitter has to be pushed non-linearly to maintain efficiency. More accurate channels and outcomes about its model retraining for various amplifiers, steering angles, and power levels were missing. This two-stage training method improves data efficiency by reusing the pre-trained receiver for various active phased array models and fading settings. The training efficiency was enhanced since several channels were trained using the same basic model. This is carried out using validation data, which are samples of data that the deep neural network did not see during training.

J. C. De Luna Ducoing et al [2023] Future wireless communication systems may see a significant improvement in connection and throughput with the help of projected MU-MIMO systems that can handle several concurrent streams. The realistic Massively Parallel Non-Linear processing detection method is used to evaluate the reliability, complexity, and resilience of four well-known model-based DL algorithms that are based on diverse working principles. Even ignoring the training phase, they are more complicated and have poorer dependability than MPNL. Due to its high complexity, memory needs, and lack of adaptation

to various channel instances, this technique was determined to have downsides by the researchers. Its high mistake rate when tested on channels different from the one it was trained on indicates that it is not very adaptable to changing channel conditions. The trade-off is a significant rise in complexity. They also struggle to adapt to new network circumstances since learning directly from data is so complicated. It takes on some of the difficulties of the EP technique, namely its excessive complexity, and adds even more complexity with the DNN. One major drawback of DL techniques is the requirement to train them, which is usually unnecessary with more traditional approaches.

Adeeb Salh et al [2021] a sixth-generation wireless communication network is an encouraging method that may be used to build a data-driven network that can assess and improve the large-scale, real-time network's behaviour and data volumes. With its help, we can achieve millisecond transmission latency and ultra-reliable, low-latency connection, which improves data transfer up to about. Distributing massive data and highly engineered artificial neural networks is computationally intensive, which is the technique's fundamental constraint. In order to boost capacity, both in terms of coverage and bandwidth. In the realm of brain-computer interfaces, it may open up new possibilities, one of which is the possibility of "using things via our brain. Particularly in far-flung situations, it is not simple to sustain. Both the mathematical model and the handling of data from previous transmissions contribute to the good quality of the data. High dependability, low latency, and increased rates of huge data are essential for Brain-Computer Interactions, which are both real and necessary. Using AI approaches for medium-access control, we are able to manage power access to the physical channel for all higher layers and accomplish network connection tasks. Making the right choices using a new deep-RL algorithm and URLLC to support UAVs is crucial for wireless communication networks to achieve optimum energy efficiency.

Latif U. Khan et al [2020] shown that smart services built on the internet of things are going to become highly popular in the future, which means that next-gen wireless networks are going to be needed. Do not meet all of the criteria for applications. A machine learning framework for 6G networks that is helped by quantum computing was one of the topics covered, along with some current research problems and state-of-the-art quantum communication techniques. Unlike radio frequency waves, visible light communication does not suffer from interference and has a very wide band width. The scalability, dependability, latency, and energy consumption of current blockchain consensus algorithms are all severely lacking. Various applications relying on visible light communication will need the development of new transceivers with low-range capabilities. The majority of the later schemes are quite intricate. The problem with solution techniques is their excessive complexity, which reduces a system's capability. The unpredictability of virtual networks makes them ideal for some tasks. Vendor animosity and the fronthaul cost issue are two other major issues.

Suren Sritharan et al [2020] summarised, several technological developments have resulted from wireless communications. These include ultra-dense networks, software-based networks, distributed antenna arrays, and network virtualisation. The need for more advanced automation in order to achieve very low latency. Give a general strategy for generating datasets to compare and contrast various learning models with more conventional optimum resource management methods for typical testing in non-stationary environments. To ensure that the learning model doesn't break down over time and cause service interruptions. The data distribution is narrow

since the non-stationarity factor k is low; as a result, the DNN model is able to learn the distribution's behaviour. Because the data being studied is always changing, models in a non-stationary setting are inevitable. Take a more practical system into account and do away with this assumption in the high-complexity situation. Since the DNN model is equally complex, it will be unable to represent a more complicated issue. The ageing effect and high computing complexity are two major problems that many wireless applications face. No amount of tweaking to the design of Neural Networks can undo the ageing impact caused by supervised learning models' reliance on training data. In most cases, there is no universally optimal set of parameters; instead, each model and set of training parameters has to be fine-tuned via ablation research and experimentation to meet the specific latency and performance goals.

Swarna B. Chetty et al [2022] The sixth generation of mobile networks is projected to provide applications and services with reduced latency, ultra-reliability, and larger data speeds compared to the fifth generation. This means that the explained universe will continue to grow with these new networks. Researchers are looking at micro service ways to solve these problems. These approaches include decomposing and loosely coupling services, which makes deployment more flexible and modular. Modelling and solving the combined challenge of decomposition and effective embedding of micro services using accurate mathematical models is no easy task. Problem complexity was so high that not even the RL model could provide an ideal answer. Due to the impossibility of determining the NNs' depth by analytical computation, a systematic experiment is conducted. Predicting the kind of service that will arrive is not possible. New expenses and limitations accompany these advantages. When applied to the embedding challenge of VNF-Forwarding Graphs, this micro service notion increases the complexity of deployment and architecture. The decoupled micro-functionalities are in need of more resources, such as latency and bandwidth. The method fails to take into account virtual link mapping and the delays it causes because of the repeating practice, making it unsuitable for networks with more users. Issues of security and heightened operational complexity are just two of the many difficult concerns raised by the real-time implementation of the micro services strategy.

Harish Viswanathan et al [2020] The emphasis in wireless research is moving closer to 6G as the rollout of 5G continues. In order to steer that investigation, it is critical to articulate a goal for future communications now. The building of digital twin worlds that accurately reflect the physical and biological worlds at every spatial and temporal instant is the essence of connectivity; these worlds will then be able to unite human experience across all three realms. The needs and capabilities of the 6G network will be influenced by newly emerging issues. Data, computation, and energy will be the new resources to be used for obtaining improved performance, as it has the potential to become the cornerstone for the 6G air interface and network. 6G will be necessary for industrial use cases that depend on much more demanding wireless communication standards. Although many automation use cases need very precise localisation in environments with strong satellite sight, this is often not the case inside. A 6G design that prioritises not just communication but also perception, understanding of the physical world, and people's needs can be achieved through RAN slice specialisations that incorporate video optimisation micro-services that are necessary for that slice but not for other slices. A difficulty that has to be addressed in the 6G network design is how to preserve sub-network privacy and possible anonymity, given the dynamic behaviour of devices entering and

departing the sub-network.

Shereen S. Omar et al [2023] Intelligent Reflecting Surfaces have the ability to greatly improve sixth-generation wireless networks, which allows for the transfer of ultra-data and the exponential growth of network capacity. Given these facts, it is important to maximise the system data rate, boost the system capacity, and minimise the chance of outages in order to deliver a better user ratio. Because of their adaptability and portability, the land infrastructure is inadequate. The data satisfaction rate ratio is used to find the proportion of connections that meet the data rate. This is based on the utilisation of the outage probability and the likelihood of pleasing users or not. There will be more neurones and bigger training data as a consequence, which raises the bar for complexity and output delay. By studying the system's capacity performance, we can determine how many IRS components are ideal for it. We find that the algorithm requires the ideal amount of IRS elements, which increases the system's user satisfaction ratio. The results of the simulation validate the high-dimensional nonconvex problem of raising the total rate of user communication. This causes output delay and device complexity to rise. Adding these components increases the power usage significantly. By using their very high data rate and excellent quality of service, links, when implemented correctly, may guarantee minimal latency and reliable data exchange. Due to the high path-loss characteristics of terahertz channels, frequencies are high, resulting in less interference from users. As a result, the algorithm's benefit is higher when the IRS is properly chosen rather than when it is arbitrarily chosen.

3. Methodology

3.1 EXISTING WORK

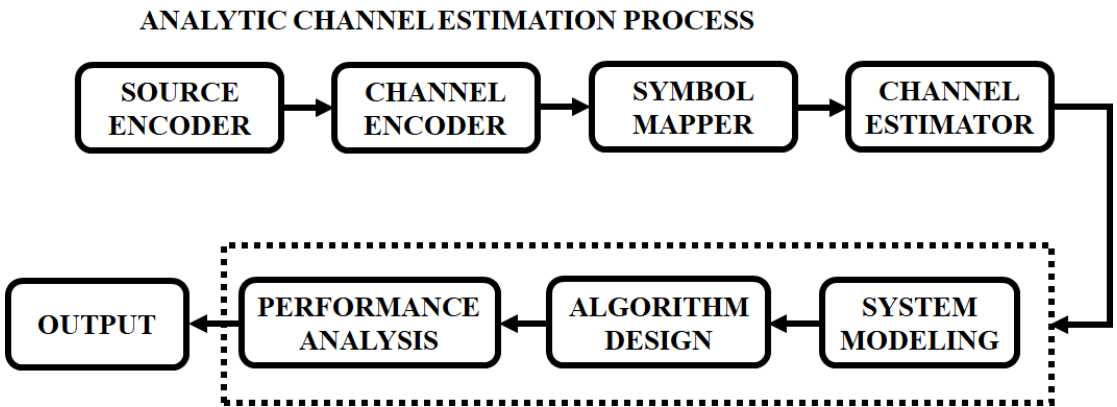

Figure 1: Block Diagram of Existing System

For 6G, our current technology offers wireless channel estimate with the use of deep learning and feedback based on channel status information. In the 6G future, DL will be the channel estimation paradigm of choice because to the proliferation of automated services and applications that utilise robots, vehicles, and sensors. Deep learning (DL), a subfield of AI methods, has demonstrated remarkable promise in a number of fields, including picture classification and segmentation, voice recognition, language translation, and others, due to its

ability to handle a wide range of frequency bands, wireless resources, and geographical settings. There has been a growing interest in using DL to wireless channel estimate in recent years, thanks to its extraordinary performance. There are a lot of moving parts and subtleties to keep in mind while using the DL approach for channel estimation, which may be daunting due to the inductive nature of DL principles and their difference from traditional rule-based algorithms. Topics covered will include 6G neural network architecture, DL model selection, training data gathering, and DL-based wireless channel estimate and channel state information (CSI) feedback. In particular, the efficacy of the DL-based wireless channel prediction framework was shown by a combination of numerical studies and many usage. Researchers in the field of communication who are interested in using the DL method for wireless channel estimate will find this study to be an invaluable resource.

3.2 DRAWBACKS OF EXISTING SYSTEM

- Nevertheless, this method's effectiveness diminishes in complex wireless settings and systems with nonlinear input-output relationships.
- Nevertheless, it imposes a substantial overhead due to the excessive transmission of training data.
- The model mismatch leads to a certain degree of performance deterioration, which may be considered non-trivial.

3.3 PROPOSED SYSTEM

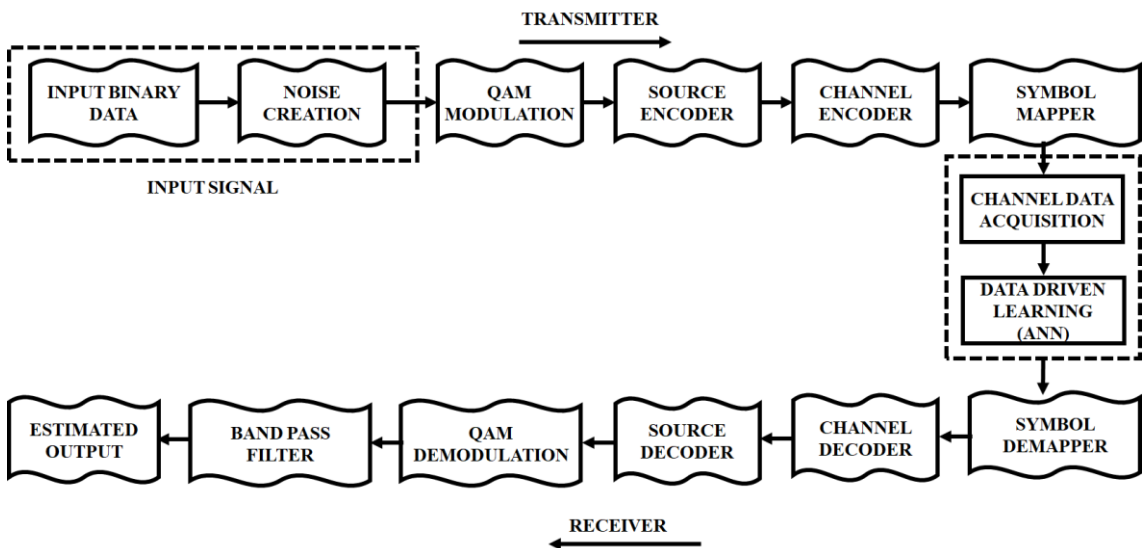

Figure 2: Block Diagram of Proposed System

Initially, the proposed system begins by subjecting input binary data to meticulous processing and controlled noise creation to emulate real-world channel conditions. The processed signal is then moved to Quadrature Amplitude Modulation (QAM). It Convert the binary data into quadrature amplitude modulation (QAM) symbols for efficient transmission. Encode the modulated symbols to improve data compression and error correction capabilities by using

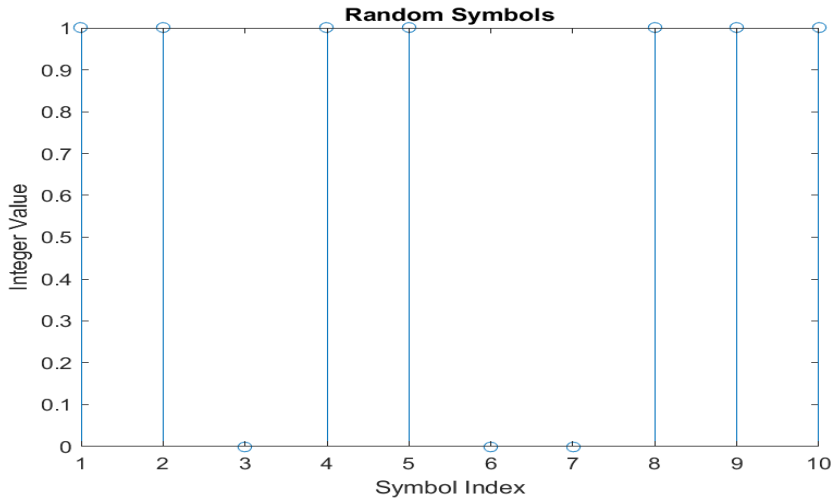

Figure 4: Random Symbol

Figure 4 displays symbols that are at random. A random symbol is a representation of a larger unit of information, and random bits are extended into random symbols. A symbol could stand in for a character, a number, or any other distinct entity. By applying a predetermined mapping method to a sequence of random bits, random symbols can be created.

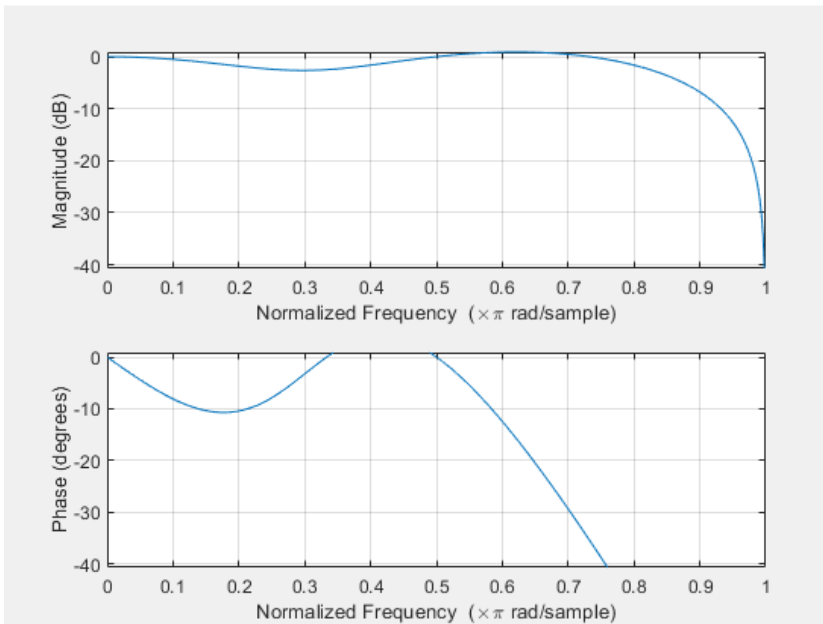

Figure 5: Normalized Frequency

This normalizes the frequency, as seen in figure 5. The normalized frequency output process involves the measurement and description of the occurrence of different symbols. The percentage of each symbol in the total number of symbols is indicated by the normalized frequency when referring to random bits or symbols.

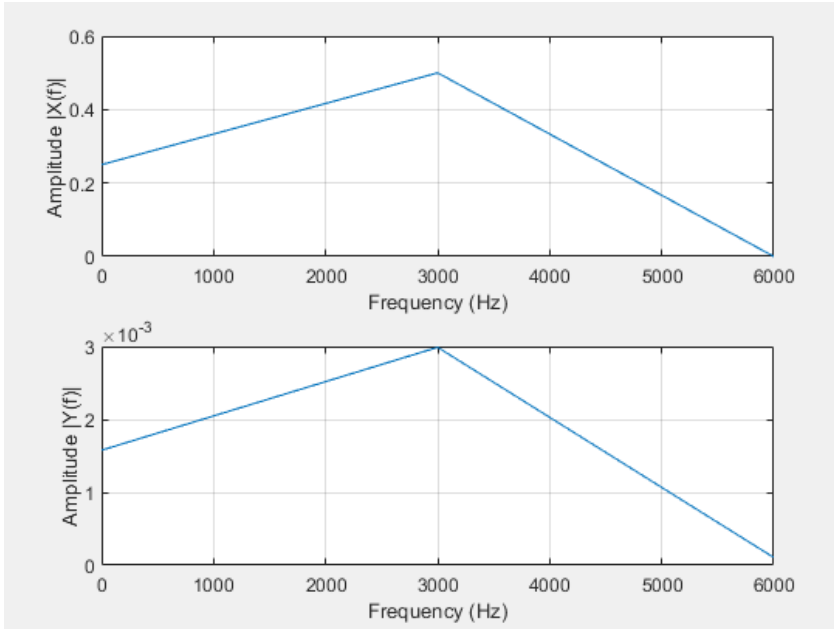

Figure 6: Frequency Range

A signal with a frequency is shown in figure 6. The range of frequencies that a signal or system may function across is referred to as its frequency range. It establishes the minimum and maximum frequencies that are used for efficient transmission, reception, or processing. The frequency range in the context of communication systems establishes the available bandwidth for information transmission.

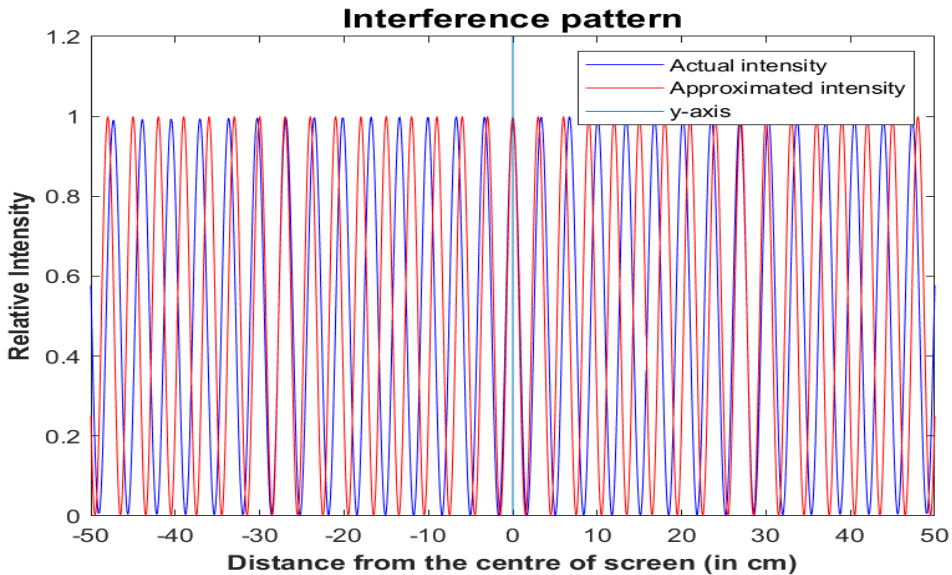

Figure 7: Interference Pattern

An interference pattern is illustrated in figure7. When two or more waves superimpose on one another, either constructive or destructive interference results, creating an interference pattern. Regions of alternating high and low intensity are what define it. Many phenomena, like double-slit interference in optics and multipath interference in radio waves, exhibit interference patterns.

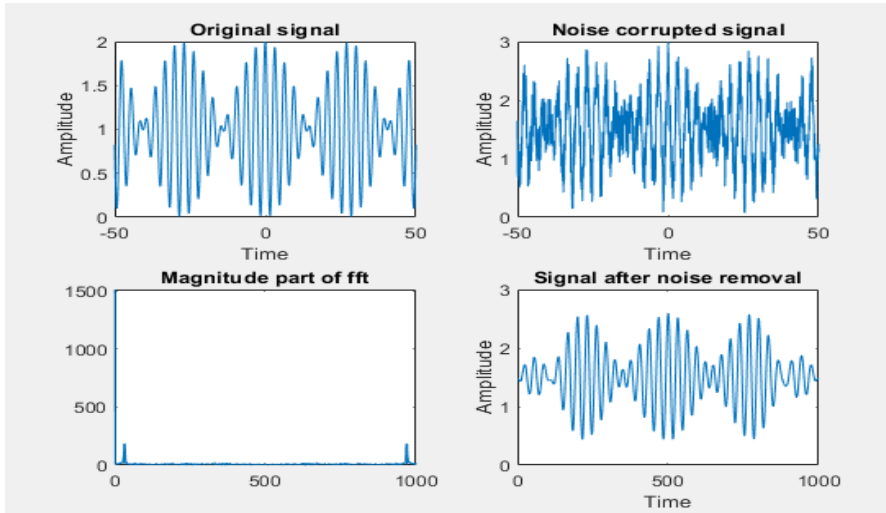

Figure 8: Noise Signal

Figure 8 shows a noise signal. Any undesired or random variation that tampers with a signal's accuracy or quality is referred to as noise. A signal with undesired random fluctuations is called noise. Many things can produce noise, including background radiation, electrical interference, and temperature variations. It can impair a signal's quality and have an impact on how well communication systems operate. The noise signal is typically unwanted and needs to be mitigated or analyzed. The output process involves techniques such as filtering, signal processing, or statistical analysis to reduce or separate the noise from the desired signal. The output is a clean signal with reduced noise or statistical measures that quantify the noise level.

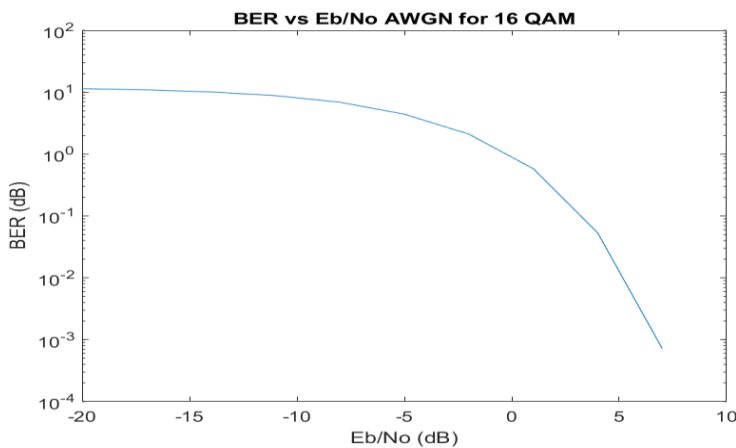

Figure 9: BER Value

A BER value is shown in figure 9. In a communication system, the transmitted and received data are compared to determine the BER value. Both the total number of bits sent and the number of bit errors are counted and analyzed during the output process. The system's performance is gauged by the resulting BER value, which is utilized for optimization, troubleshooting, or comparison with predetermined performance standards.

5. Conclusion

This project, enhanced wireless channel state estimation through deep learning for 6g communication, was implemented. The proposed DL-based channel estimator offers a promising solution to accurately estimate the characteristics of communication channels. By leveraging the capabilities of deep learning algorithms, it is possible to overcome the limitations of traditional channel estimation techniques and adapt to complex and time-varying channel conditions. The integration of the DL-based channel estimator enhances the performance of communication systems, improving signal demodulation, equalization, and overall system reliability. This solution has the potential to benefit various domains, such as wireless communication, where accurate channel estimation is critical for efficient and robust communication. By integrating source encoding, channel encoding, symbol mapping, and a DL-based channel estimator, the proposed solution offers a comprehensive approach to optimizing communication system performance. MATLAB software was used in the implementation of this project.

References

1. B. Mthethwa and H. Xu, "Deep Learning-Based Wireless Channel Estimation for MIMO Uncoded Space-Time Labeling Diversity," in *IEEE Access*, vol. 8, pp. 224608-224620, 2020.
2. H. Djelouat, M. Leinonen, L. Ribeiro and M. Juntti, "Joint User Identification and Channel Estimation via Exploiting Spatial Channel Covariance in mMTC," in *IEEE Wireless Communications Letters*, vol. 10, no. 4, pp. 887-891, April 2021.
3. S. Huang, M. Zhang, Y. Gao and Z. Feng, "MIMO Radar Aided mmWave Time-Varying Channel Estimation in MU-MIMO V2X Communications," in *IEEE Transactions on Wireless Communications*, vol. 20, no. 11, pp. 7581-7594, Nov. 2021.
4. J. Wang et al., "Estimation of Rice Factor Ratio for Doubly Selective Fading Channels," in *IEEE Access*, vol. 8, pp. 31330-31340, 2020.
5. Q. Hu, F. Gao, H. Zhang, S. Jin and G. Y. Li, "Deep Learning for Channel Estimation: Interpretation, Performance, and Comparison," in *IEEE Transactions on Wireless Communications*, vol. 20, no. 4, pp. 2398-2412, April 2021.
6. Z. Yi and W. Zou, "A Novel NE-DFT Channel Estimation Scheme for Millimeter-Wave Massive MIMO Vehicular Communications," in *IEEE Access*, vol. 8, pp. 74965-74976, 2020.
7. Y. Gao and T. Fujii, "A Kriging-Based Radio Environment Map Construction and Channel Estimation System in Threatening Environments," in *IEEE Access*, vol. 11, pp. 38136-38148, 2023.
8. N. Parvaresh and B. Kantarci, "A Continuous Actor-Critic Deep Q-Learning-Enabled Deployment of UAV Base Stations: Toward 6G Small Cells in the Skies of Smart Cities," in *IEEE Open Journal of the Communications Society*, vol. 4, pp. 700-712, 2023.
9. L. Wang, D. Han, M. Zhang, D. Wang and Z. Zhang, "Deep Reinforcement Learning-Based Adaptive Handover Mechanism for VLC in a Hybrid 6G Network Architecture," in *IEEE*

- Access, vol. 9, pp. 87241-87250, 2021.
10. K. M. Naguib, I. I. Ibrahim, M. M. Elmesalawy and A. M. A. Elhaleem, "DL-Based Minimizing Virtual Environment Resource Usage in 6G Cellular Networks," in *IEEE Access*, vol. 11, pp. 118241-118252, 2023.
 11. B. Ozpoyraz, A. T. Dogukan, Y. Gevez, U. Altun and E. Basar, "Deep Learning-Aided 6G Wireless Networks: A Comprehensive Survey of Revolutionary PHY Architectures," in *IEEE Open Journal of the Communications Society*, vol. 3, pp. 1749-1809, 2022.
 12. M. H. Nielsen, E. De Carvalho and M. Shen, "A Two-Stage Deep Learning Receiver for High Throughput Power Efficient LEO Satellite System With Varied Operation Status," in *IEEE Access*, vol. 10, pp. 60904-60913, 2022.
 13. F. B. Mismar, A. Gündoğan, A. Ö. Kaya and O. Chistyakov, "Deep Learning for Multi-User Proactive Beam Handoff: A 6G Application," in *IEEE Access*, vol. 11, pp. 46271-46282, 2023.
 14. J. C. De Luna Ducoing, C. Jayawardena and K. Nikitopoulos, "An Assessment of Deep Learning Versus Massively Parallel, Non-Linear Methods for Highly-Efficient MIMO Detection," in *IEEE Access*, vol. 11, pp. 97493-97502, 2023.
 15. A. Salh et al., "A Survey on Deep Learning for Ultra-Reliable and Low-Latency Communications Challenges on 6G Wireless Systems," in *IEEE Access*, vol. 9, pp. 55098-55131, 2021.
 16. L. U. Khan, I. Yaqoob, M. Imran, Z. Han and C. S. Hong, "6G Wireless Systems: A Vision, Architectural Elements, and Future Directions," in *IEEE Access*, vol. 8, pp. 147029-147044, 2020.
 17. S. Sritharan, H. Weligampola and H. Gacanin, "A Study on Deep Learning for Latency Constraint Applications in Beyond 5G Wireless Systems," in *IEEE Access*, vol. 8, pp. 218037-218061, 2020.
 18. S. B. Chetty, H. Ahmadi, M. Tornatore and A. Nag, "Dynamic Decomposition of Service Function Chain Using a Deep Reinforcement Learning Approach," in *IEEE Access*, vol. 10, pp. 111254-111271, 2022.
 19. H. Viswanathan and P. E. Mogensen, "Communications in the 6G Era," in *IEEE Access*, vol. 8, pp. 57063-57074, 2020.
 20. S. S. Omar, A. M. A. El-Haleem, I. I. Ibrahim and A. M. Saleh, "Capacity Enhancement of Flying-IRS Assisted 6G THz Network Using Deep Reinforcement Learning," in *IEEE Access*, vol. 11, pp. 101616-101629, 2023.